



TECHNICAL GUIDANCE

VF-3000

Vortex Flow Sensor

The VF-3000 Flow Sensor offers a cost-effective instrument for the measurement of liquid flow.

A simple and clean design makes the VF-3000 a good choice for the measurement of ultra-pure water, DIW (de-ionized water) in semiconductor manufacturing plants.

Current output model, Pulse output model and Display model with current / alarm outputs are available.

All PFA fused construction version has been added, the VF-3000 is an ideal choice for plant where the extreme cleanness of pipe is required.



FEATURES

- ❑ **Wide flow range enough to cover minimum 0.3 L/min and maximum 150L/min.**
- ❑ **Designed for Cleanness**
Sensor body is made of New PFA (420HP-J). All PFA fused construction version has been lined up and designed to eliminate the deposit.
- ❑ **No Maintenance Cost**
Since the VF-3000 has no moving parts, no maintenance is needed.
- ❑ **Simple and Compact Design**
The VF-3000 Flow Sensor is assembled with a few pieces of components. The sensor body and Shedder bar (vortex generator) are molded as one component. This design approach has reduced the cost as well as the size and weight of the flowmeter.
- ❑ **CE Marking**
The VF-3000 meets the EMC directive for CE mark.
- ❑ **3 models are lined-up.**
The function can be selected depending upon the application.

Display + Current output model

4 to 20mA output (3-wire), LED indicator, 2 points alarm output (Open collector)

Current output model

4 to 20mA output (3-wire)

Pulse output model

Open collector output (Unscaled pulse)

* The flow range of All PFA fused construction version is 0.3 to 2.5L/min, 0.5 to 4L/min or 15 to 150L/min.

OPERATING PRINCIPLE

A bluff body or Shedder bar in the flow generates a street of vortices downstream. The VF-3000 Flow Sensor measures the flow rate by counting the number of vortices with a piezoelectric sensor.

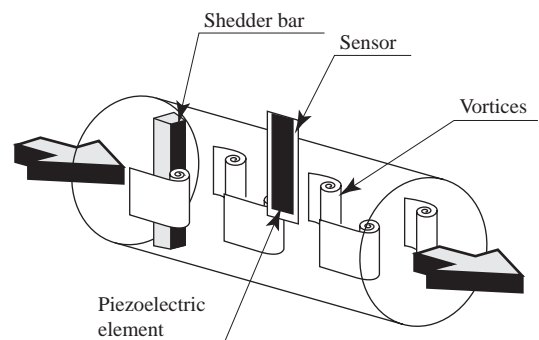

STANDARD SPECIFICATION

Specification		Model			
		Current Output Model	Pulse Output Model	Display + Current output Model	
		VF-301□	VF-302□	VF-303□	
Measuring fluid		Ultra-pure water, Water, Chemical liquid (low viscosity)			
Flow range / Conn. size*1	VF-30□0	0.3 to 2.5L/min or 0.08 to 0.65GPM / 3/8"			
	VF-30□1	0.5 to 4L/min or 0.13 to 1GPM / 3/8"			
	VF-30□2	2 to 16L/min or 0.5 to 4GPM / 3/4"			
	VF-30□3	4 to 40L/min or 1 to 10GPM / 3/4"			
	VF-30□5	15 to 150L/min or 4 to 40GPM / 1"			
Process connection		PFA tube end [Standard] or PFA tube fitting [Refer to Table of MODEL Code]			
Accuracy*1		±3%F.S.	±3%F.S. (1digit)		
Reproducibility		±0.5%F.S.			
Fluid pressure		0 to 0.5MPa [Refer to Figure 3]			
Fluid Temperature		0 to 90°C	0 to 90°C [Refer to Figure 4]		
Ambient Temperature		0 to 50°C	0 to 50°C [Refer to Figure 4]		
Ambient Humidity		5 to 90%RH			
Power supply		10.8 to 26.4V DC			
Power consumption		1W	0.5W	2W	
Display	Flow rate	-		3-digit LED	
	Alarm	-		2 LED (Alarm-1, Alarm-2)	
Display resolution	VF-3030/3031	-		0.01L/min or 0.01 GPM	
	VF-3032	-		0.1L/min or 0.1 GPM	
	VF-3033	-		0.1L/min or 0.1 GPM	
	VF-3035	-		1L/min or 1 GPM	
Output		<ul style="list-style-type: none"> ● Current output 4 to 20mA (3-wire) Load: 0 to 250 ohms at 12V DC 250 to 600 ohms at 24V DC [Refer to Load Resistance Range for Current Output] Damping Time Constant: 1s (63% Response) 	<ul style="list-style-type: none"> ● Pulse output [Unscaled pulse] Open collector: Max. 10mA/30V DC Pulse duty factor: approx.50% 	<ul style="list-style-type: none"> ● Current output 4 to 20mA (3-wire) Load: 0 to 250 ohms at 12V DC 250 to 600 ohms at 24V DC [Refer to Load Resistance Range for Current Output] Response: Sampling time 0.5S + Damping time constant 2.5S ● Alarm output Alarm-1 and Alarm-2 Open collector Max. 80mA, 30V DC Hysteresis : equal to display resolution 	
					Output frequency at 100% flow
					VF-3020 750Hz at 2.5L/min
					VF-3021 867Hz at 4L/min
					VF-3022 860Hz at 16L/min
					VF-3023 596Hz at 40L/min
VF-3025 900Hz at 150L/min					
Cable	0.2mm ² x 3C (AWG24), 3m, Outside diameter 3.5mm (Soldered end finish)			0.2mm ² x5C (AWG24) 3m, Outside diameter 4.5mm (Soldered end finish)	
	Enclosure Classification IP64				
Material	Wetted part	Sensor body	New PFA (420HP-J)		
		Tube	New PFA (equivalent to 450HP)		
		Fitting	PFA or New PFA		
		Sensor	Piezoelectric element molded with New PFA (420HP-J)		
		O-ring	Perfluoro elastomer (PF) or without o-ring (Fused construction for sensor part)*2		
	Cover	Poly-butylene trephthalate (PBT)			
	Cable sheath	Heat resistant PVC			
Mass	Meter	80 to 220g (Mass changes depending on type of fitting)	100 to 240g (Mass changes depending on type of fitting)		
	Cable	75g	90g		
Min. Straight Pipe Run	VF-30□0/30□1	50mm upstream (Not required downstream)			
	VF-30□2	80mm upstream (Not required downstream)			
	VF-30□3				
	VF-30□5	Upstream 180mm, Downstream 50mm			

*1 Conditions for calibration

Fluid : Water, Fluid temperature : 25°C

Ambient temperature : 23°C, Supply voltage : 24 VDC

*2 : The flow range of All PFA fused construction version is 0.3 to 2.5L/min, 0.5 to 4L/min or 15 to 150L/min.

Fluid Pressure and Temperature

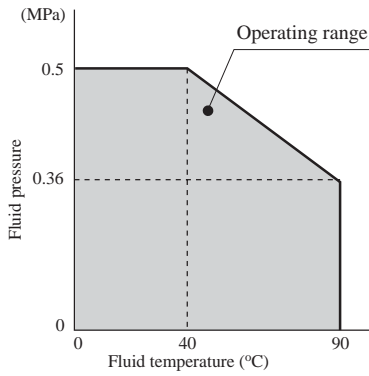

Fluid and Ambient Temperature

(for Display model VF-303□)

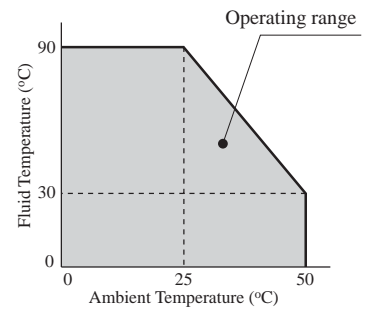

WIRING DIAGRAM

● Current Output Model (VF-301□)

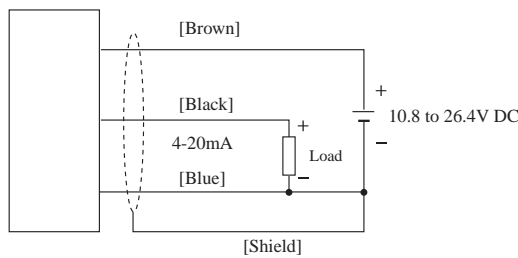

● Pulse Output Model (VF-302□)

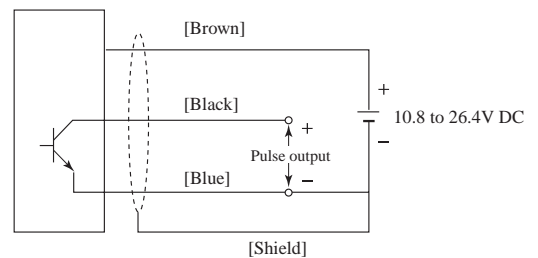

● Display + Current Output Model (VF-303□)

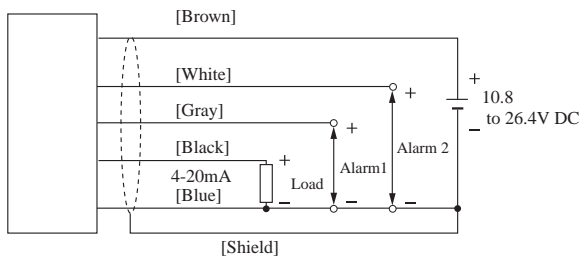

Load Resistance Range for Current Output

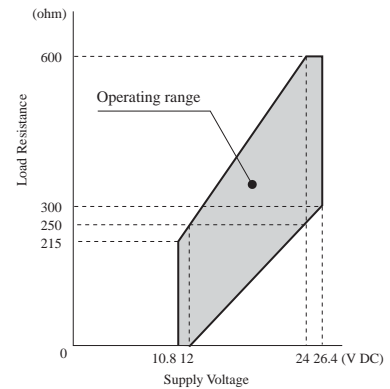

MODEL CODE

Model code					Description
VF - 30	□	□	- □	□ □	
Output	1				Current output : 4-20mA
	2				Pulse output : Open collector (Unscaled pulse)
	3				Display : Flow rate (3-digit LED), Alarm (2 LED) Current output : 4 to 20mA Alarm output : Open collector (2 points)
Flow range / Connection size	0				0.3 to 2.5L/min or 0.08 to 0.65GPM / 3/8"
	1				0.5 to 4L/min or 0.13 to 1GPM / 3/8"
	2				2 to 16L/min or 0.5 to 4GPM / 3/4"
	3				4 to 40L/min or 1 to 10GPM / 3/4"
O-ring			- P		Perfluoro erastomer (PF) [VF-30□2, VF-30□3]
			- 0		Without o-ring (Fused construction for sensor part) [VF-30□0, VF-30□1, VF-30□5]
Process Connection				0	PFA Tube end [Standard]
				1	FLARETECK
				2	PILLAR [SUPER TYPE PILLARFITTING]
				3	FINALLOCK
				4	Flowell [20 Series Tube Fittings]
				5	Flowell [20A Series Tube Fittings]
				6	Flowell [60 Series Tube Fittings]
Flow Unit				1	L/min
				2	GPM

OUTLINE DIMENSIONS

- VF-301□
 - VF-302□
- (Tube end type)

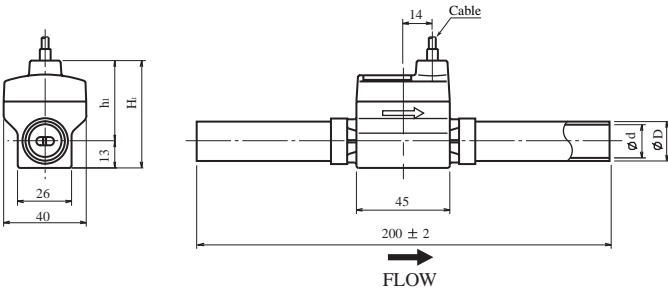

- VF-303□
- (Tube end type)

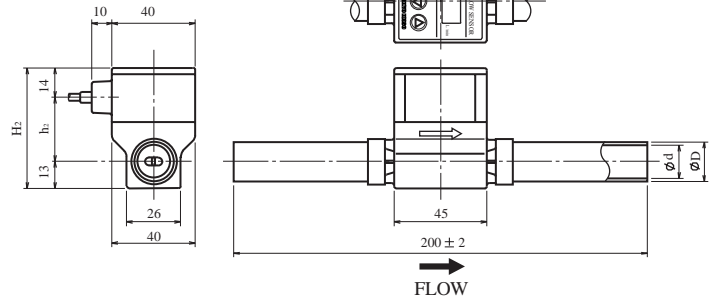

- VF-301□
 - VF-302□
- (Fitting type)

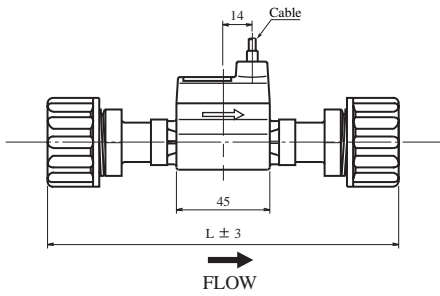

- VF-303□
- (Fitting type)

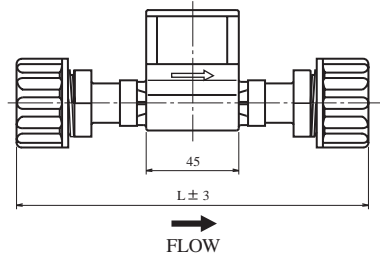

Unit : mm

Model	Conn. size	Dimension								D	d	H ₁	h ₁	H ₂	h ₂
		L (Refer to MODEL CODE for Process connection)													
		-□0□	-□1□	-□2□	-□3□	-□4□	-□5□	-□6□	-□7□						
VF-30□0 VF-30□1	3/8"	200	170	160	165	150	150	200	155	9.53	6.35	52	39	58	31
VF-30□2	3/4"	200	185	190	170	165	165	220	185	19.05	15.9	52	39	58	31
VF-30□3	3/4"	200	185	190	170	165	165	220	185	19.05	15.9	53.5	40.5	59.5	32.5
VF-30□5	1"	250	225	235	210	200	200	255	230	25.4	22.2	67	47	73	39

ORDERING INSTRUCTION

Specify the following when ordering:

1. Model code
2. Fluid name

*Specification is subject to change without notice.

TIV TOKYO KEISO CO., LTD.

Head Office : Shiba Toho Building, 1 - 7 - 24 Shibakoen, Minato-ku, Tokyo 105 - 8558
 Tel : 03 - 3431 - 1625 (KEY) ; Fax : 03 - 3433 - 4922
 e-mail : overseas.sales@tokyokeiso.co.jp ; URL : http://www.tokyokeiso.co.jp

