



TECHNICAL GUIDANCE

VF-2200

Vortex Flow Sensor for water

OUTLINE

The VF-2200 Flow Sensor is an improved version of well-received VF-2000 and has wider flow range than VF-2000. The VF-2200 Flow Sensor offers a cost-effective instrument for the measurement of liquid flow.

A simple and compact design makes the VF-2200 a good choice for the measurement of water, pure water, cooling water.

Current output model, Pulse output model and Display model with current / alarm outputs are available. Fitting is selectable from various types according to use.

FEATURES

- ❑ Simple and Compact Design
The VF-2200 Flow Sensor is assembled with a few pieces of components. The sensor body and Shedder bar (vortex generator) are molded as one component. This design approach has reduced the cost as well as the size and weight of the flowmeter. Sensor body is made of PPS (Polyphenylene sulfide) and is designed to eliminate deposits.
- ❑ No Maintenance Cost
Since the VF-2200 has no moving parts, no maintenance is needed.
- ❑ Low Pressure Loss
A combination of straight flow path and Shedder bar gives a lower pressure loss compared with other types of flowmeters.
- ❑ Linear Output
Output signal is proportional to a volumetric flow rate.
- ❑ Display Model with Current and Alarm Output
3-digit LED display for flow rate, current output and alarm outputs (2-point) are provided in compact design.
- ❑ CE Marking
The VF-2200 meets the EC directive for CE mark.

OPERATING PRINCIPLE

A bluff body or Shedder bar in the flow generates a street of vortices downstream. The VF-2200 Flow Sensor measures the flow rate by counting the number of vortices with a piezoelectric sensor.

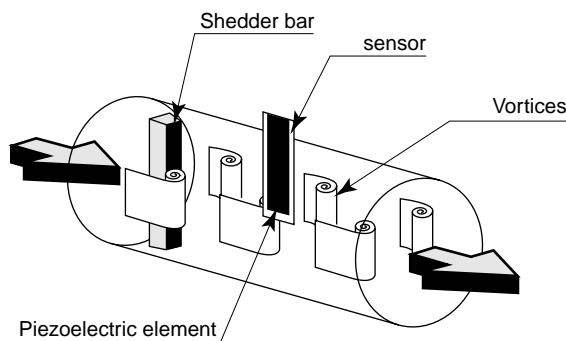

Figure 1



SPECIFICATIONS

Specifications		Model		
		Current Output Model	Pulse Output Model	Display Model
		VF-2215-F□1	VF-2225-F□1	VF-223□-F□1
Measurable Fluid		Pure water, Water		
Flow Range *1		10~150 L/min		10~100L/min or 10~150L/min
Accuracy (Additional Error for LED display)*1		±3%F.S.		±3%F.S. (1 digit)
Repeatability		±0.5%F.S		
Fluid Pressure		0~0.98MPa [Refer to Figure 4&5]*2		
Fluid Temperature		0~50°C (Fitting Material : PVC) 0~90°C (Fitting Material : HT-PVC) [Refer to Figure 4&5]*2		
Ambient Temperature		0~50°C		0~50°C [Refer to Figure 2]
Ambient Humidity		5~90%RH		
Operating Voltage		10.8~26.4V DC		
Rated Power		1W	0.5W	2W
Display	Flow	-		3-digit LED
	Alarm	-		2 LED
Display Resolution	VF-223□	-		1L/min
Output	Current output 4~20mA DC (3-wire) Load : 0~250 ohms at 12V DC 250~600 ohms at 24V DC [Refer to Figure 3] Damping Time Constant 1sec (63% Response)	Unscaled pulse output Open collector Max. 10mA/30V DC Pulse duty factor ; approx 50% Output frequency at 100% flow*1 900Hz	Current output 4~20mA DC (3-wire) Load : 0~250 ohms at 12V DC 250~600 ohms at 24V DC [Refer to Figure 3] Damping Time Constant 1sec (63% Response) Alarm output (2-point) Open collector, Max. 80mA/30V DC Hysteresis ; equal to display resolution	
	Cable	0.2mm ² X 3C (AWG24), 3m, Outside diameter 3.5mm (Soldered end finish)		0.2mm ² X5C (AWG24), 3m, Outside diameter 4.5mm (Soldered end finish)
Mass	Body	335~860g (Mass changes depending on type of fitting)		370~900g (Mass changes depending on type of fitting)
	Cable	75g		90g
Enclosure Classification		IP64		
Min. Straight Pipe Run		Upstream 10D, Downstream 5D (D: Normal Pipe Size)		
Process Connection	Nominal size	25mm (1")		
	Fitting	TS Socket, JIS10K FF Flange, Taper Pipe Threads (Rc1)		
Body Materials	Body	PPS (Polyphenylene sulfide)		
	Sensor	Piezoelectric element molded with PPS		
	O-ring	Fluorine rubber (FKM)		
	Cover	Poly-butylene terephthalate (PBT)		
	Cable sheath	Heat-resistant PVC		
Fitting Materials	Fitting	PVC or HT-PVC		
	O-ring	Fluorine rubber (FKM)		

*1 Conditions for calibration

Fluid : Water, Fluid temperature : 20°C, Ambient temperature : 23°C, Supply voltage : 24V DC

*2 Specifications of pressure and temperature may change depending on specification of fitting.

Fluid and Ambient Temperature (Only for Display type VF-223□)

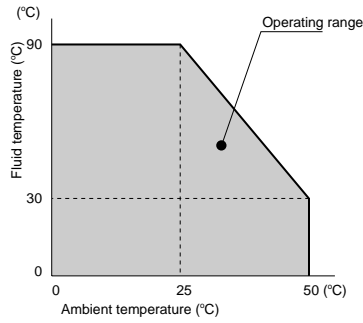

Figure 2

Load Resistance Range (VF-2215, VF-223□)

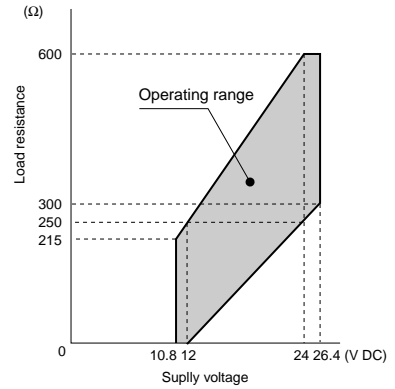

Figure 3

Fluid Pressure and Temperature

Fitting material : PVC

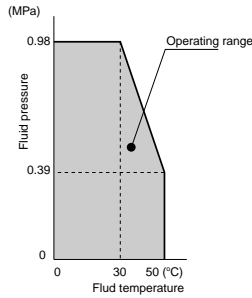

Figure 4

Fitting material : HT-PVC

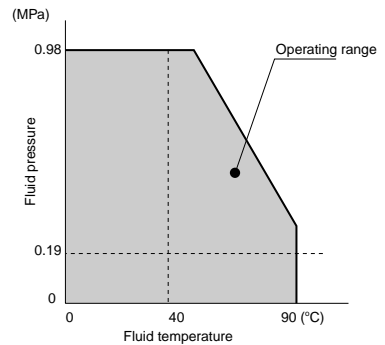
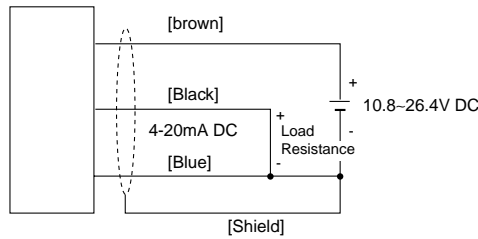

Figure 5

WIRING DIAGRAM

● Current Output Model (VF-2215)



● Pulse Output Model (VF-2225)

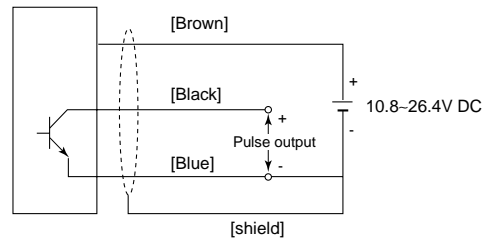

● Display / Current Output Model (VF-223□)

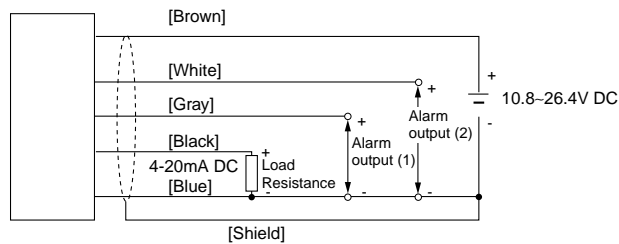

Figure 6

MODEL CODE

Model code							Description
VF - 22	□	□	- □	□	□	/ □	
Type/Output	1						Current output : 4-20mA DC(3-wire)
	2						Pulse output : Open collector (Unscaled)
	3						Display : Flow rate (3-digit LED), Alarm (2 LED) Current output : 4-20mA DC (3-wire) Alarm output : Open collector (2 points)
Flow Range	4						10-100 L/min (VF-2234 : only for Display model)
	5						10-150 L/min
O-ring Material			- F				Fluorine rubber (FKM)
Process Connection	1						PVC / 25mm (1") TS Socket
	2						PVC / 25mm (1") JIS10K FF Flange
	3						PVC / Rc1 Taper Pipe Threads
	4						HT-PVC / 25mm (1") TS Socket
	5						HT-PVC / 25mm (1") JIS10K FF Flange
Flow Unit				1			L/min
Option						/ □	Option Code

OUTLINE DIMENSIONS

● TS socket

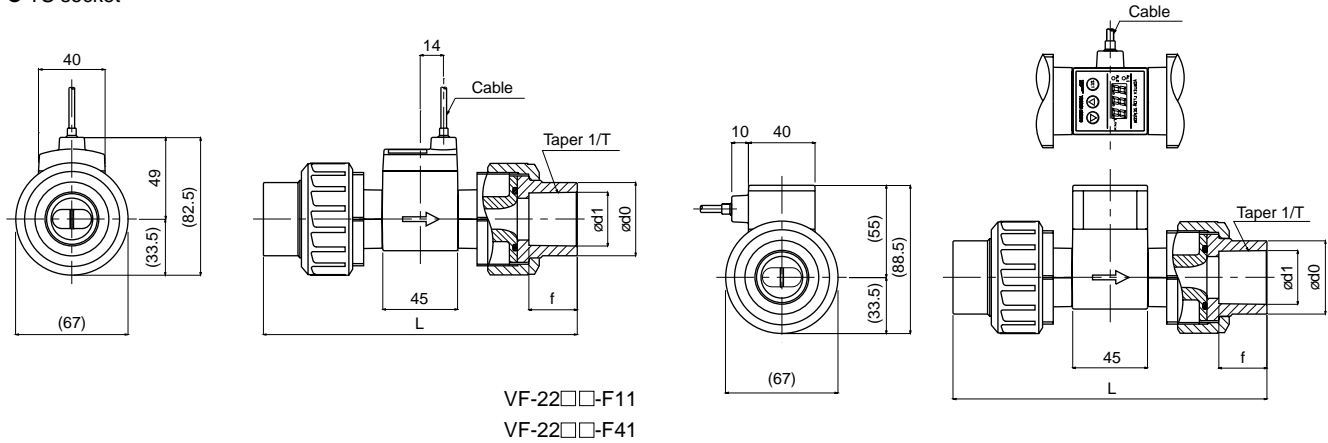

TS socket type				
L	1/T	f	d1	d0
182	1/43	29	32.3	44

● JIS10K Flange type

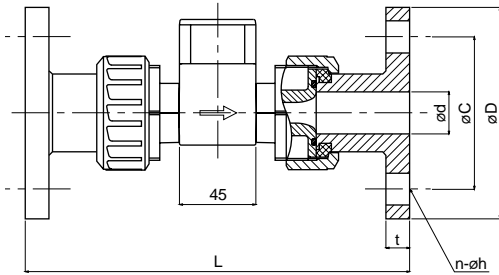

VF-22□□-F21
VF-22□□-F41

JIS 10K Flange type					
L	D	C	d	n-øh	t
227	125	90	25	4-19	14

● Taper pipe thrad type

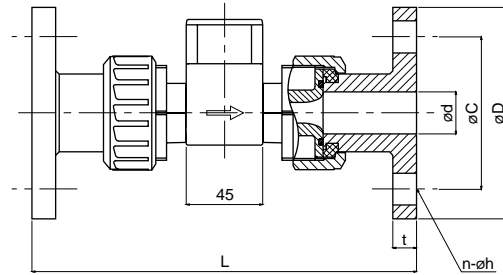

VF-22□□-F31

Taper pipe thread (Rc) type	
Nominal size	L
Rc1	177

Figure 7

ORDERING INSTRUCTIONS

Specify the following when ordering:

1. Model code
2. Fluid name

* Specification subject to change without notice

TIV TOKYO KEISO CO., LTD.

Head Office : Shiba Toho Building, 1-7-24 Shibakoen, Minato-ku, Tokyo 105-8558
Tel : 03-3431-1625 (KEY) ; Fax : 03-3433-4922
e-mail : overseas.sales@tokyokeiso.co.jp ; URL : http://www.tokyokeiso.co.jp

