

## 871CC Contacting Conductivity and Resistivity Sensors and Accessories

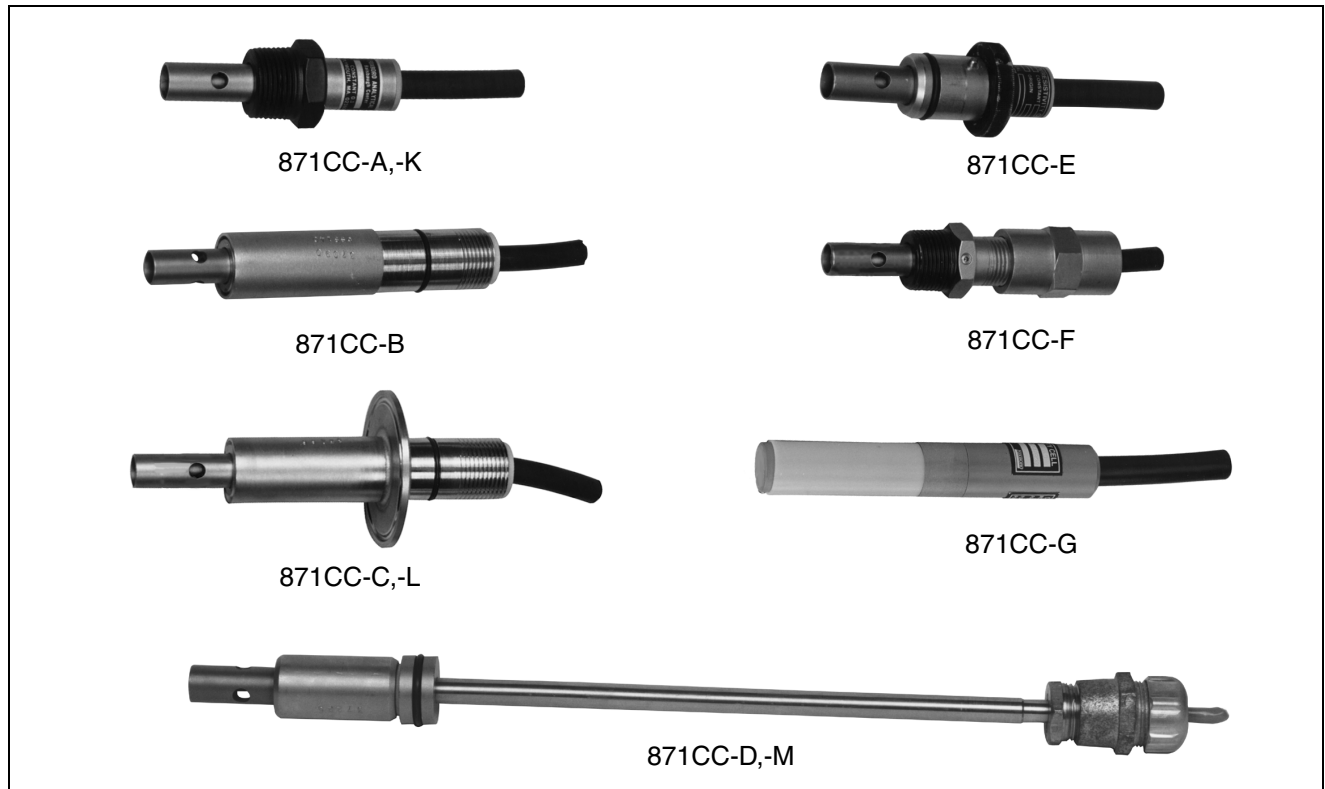

Foxboro 871CC Sensors (Cells), in conjunction with supporting 871CC accessories, offer a dependable, fast, durable, and in-line means of measuring ionic content of a sample stream. As symbolized by the “CE” Logo marking on the product, these sensors conform to the applicable European Union directives when used with the electrochemical analyzers listed below.

### INTRODUCTION

871CC Contacting Conductivity/Resistivity Sensors are used with Foxboro 873CC, 873RS, 873ACC, 873ARS, 875CR, and 870ITCR Electrochemical Analyzers and Transmitters to detect the conductivity or resistivity of a solution. The analyzer applies a low frequency voltage or current across the sensor electrodes in contact with the process fluid. The resulting electrical parameter is sampled, interpreted, temperature-corrected, and displayed by the analyzer.

### APPLICATION FLEXIBILITY

A choice of two cell factors,  $0.1 \text{ cm}^{-1}$  and  $10 \text{ cm}^{-1}$ , is available for conductivity measurement. The required cell factor is dictated by the measurement type and range. Resistivity measurements always use a sensor having a cell factor of  $0.1 \text{ cm}^{-1}$ . Conductivity measurements utilize both cell factors. 871CC Sensors are offered with a wide variety of mounting options and a choice of two temperature elements.

**QUALITY AND UNIFORMITY**

871CC Sensors are manufactured under strict guidelines of quality and uniformity to ensure that all cell factors are within 2% of their nominal value. All sensors with 0.1 cm<sup>-1</sup> cell factor (CF) have the actual CF stamped on the sensor. The actual CF is determined using NIST traceable quality procedures. Optionally, resistivity cell factors can be determined in a Foxboro ultra-pure water loop (Options Code -9).

Simply enter the CF and temperature CF into the applicable factory-calibrated analyzer and you have a fully-calibrated measurement system!

**INTEGRAL TEMPERATURE SENSOR**

All sensors use an integral temperature element whose signal is used by the analyzer for temperature compensation and measurement. Sensors are available with either a 100 kΩ thermistor or 100 Ω RTD. For elevated temperatures, the 100 Ω RTD is recommended. Optimum positioning of these transducers within the sensor ensures close thermal contact with the process and, thus, rapid response to temperature change.

Temperature cell factors (tCF) are determined and stamped on each 0.1 cm<sup>-1</sup> cell-factor sensor. This factor indicates the offset, in °C, resulting from the resistance of the RTD or thermistor cable. Entering this value into the analyzer or transmitter accurately calibrates the RTD or thermistor to the instrument.

**TITANIUM, MONEL AND CARBON ELECTRODES**

The 0.1 cm<sup>-1</sup> CF sensor is constructed with titanium or Monel™ electrodes. Titanium oxidizes naturally to form a chemically passive but electrically conducting surface. It is compatible with most fluids except acidic fluorides. For applications using acidic fluorides, Monel electrodes can be used. The electrodes have a concentric cylinder configuration.

The 10 cm<sup>-1</sup> cell-factor sensor uses high density graphite electrodes.

**VARIETY OF ACCESSORIES**

A large selection of accessories is offered to meet virtually all process requirements. This includes process-mounting accessories such as flow chambers, gate valve assemblies, and tees.

**Measurement Range of Sensors and Conductivity Ranges of Common Aqueous Solutions**

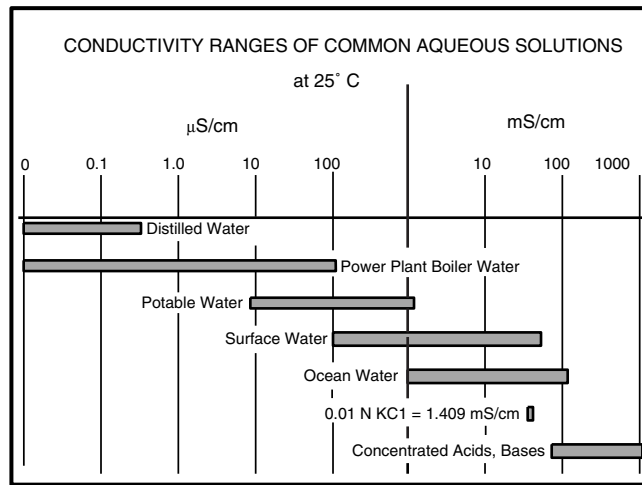
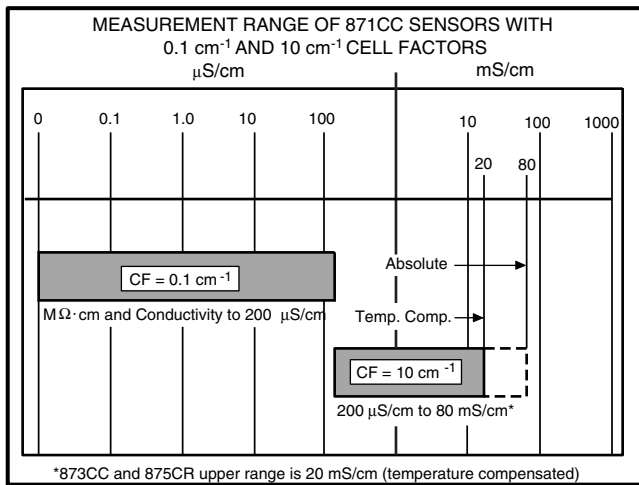

**Conversion Table - μS/cm versus Ohm-cm - at 25°C (77°F)**











Conductance μS/cm	Resistance Ohm-cm	Conductance μS/cm	Resistance Ohm-cm	Conductance μS/cm	Resistance Ohm-cm
0.055	18 300 000	2	500 000	26	38 461
0.063	16 000 000	4	250 000	30	33 333
0.071	14 000 000	6	166 667	40	25 000
0.083	12 000 000	8	125 000	50	20 000
0.100	10 000 000	10	100 000	60	16 667
0.125	8 000 000	12	83 333	80	12 500
0.167	6 000 000	14	71 428	100	10 000
0.25	4 000 000	16	62 500	120	8 333
0.5	2 000 000	18	55 555	160	6 250
1	1 000 000	22	45 454	200	5 000

## MODEL CODE

<b>Description</b>	<b>Model</b>
Contacting Conductivity or Resistivity Sensor (a)	871CC
<b>Sensor Mounting and Transducer</b>	
Threaded Bushing, 3/4 NPT	Thermistor, 100 k $\Omega$ -A
Universal	Thermistor, 100 k $\Omega$ -B
Sanitary	Thermistor, 100 k $\Omega$ -C
Insertion	Thermistor, 100 k $\Omega$ -D
Twist-Lock	Thermistor, 100 k $\Omega$ -E
Threaded Bushing, 3/4 NPT with 1/2 NPT Conduit Connector	Thermistor, 100 k $\Omega$ -F
Dip Sensor	Thermistor, 100 k $\Omega$ -G
Threaded Bushing, 3/4 NPT, High Temperature (b)	RTD, 100 $\Omega$ -K
Sanitary, High Temperature (b)	RTD, 100 $\Omega$ -L
Insertion, High Temperature (b)	RTD, 100 $\Omega$ -M
<b>Cell Factor and Electrode Material</b>	
0.1 cm <sup>-1</sup> , Titanium	2
10 cm <sup>-1</sup> , Graphite	4
0.1 cm <sup>-1</sup> , Monel (Mounting Codes -A, -G, and -K only)	6
<b>Optional Selections (c)</b>	
Nonstandard Cable Length (Specify length) (d)	-3
No Spade Lug Terminals Attached to End of Cable	-4
Nonstandard Length Integral Cable Terminated in Connector. Specify Length. For Mounting Codes -A and -G only. (d)(e)	-5
Integral Connector on Sensor. For Mounting Code -A only. (e)(f)	-6
Standard Length (6 m [20 ft]) Integral Cable Terminated in Connector. For Mounting Codes -A and -G only. (e)(f)	-7
Cell Factor Determined in Foxboro Pure Water Loop	-9
Examples: 871CC-B2; 871CC-A4-34 (40 ft); 871CC-A2-349 (20 m)	

- (a) When 871CC Series Sensor is used with 873RS, 873ARS, 873CC, 873ACC, or 875CR Series Analyzer, Option Code -4 must be specified.
- (b) The -K, -L, and -M sensors contain an integral 100 $\Omega$  RTD for automatic temperature compensation. This RTD is compatible with 873RS, 873ARS, 873CC, 873ACC, and 875CR Series Analyzers, and 870ITCR Series Transmitters. No temperature compensation can be applied when used with 870 Series Transmitters.
- (c) Except for Option Codes -3, -4, and -9 which may be combined (e.g., -34, -349, etc.), only one Option Code may be specified.
- (d) Maximum cable length:  
 – for 870CC and 870ITCR Transmitters, 30 m (100 ft);  
 – for 873RS, 873ARS, 873CC, 873ACC, and 875CR Analyzers, 150 m (500 ft).
- (e) Requires use of Patch Cord numbers, as follows:  
 – BS805UA, 3 m (10 ft) length  
 – BS805UB, length per Sales Order to 30 m (100 ft) maximum.
- (f) Not recommended for resistivity measurement.

**SENSOR APPLICATIONS**

Sensor Body Code	Applications	Sensor
-A	Standard sensors incorporating a 3/4 NPT Teflon™-S coated bushing. Offers a wide variety of installation configurations. Mating cell holders are also available.	
-B	Universal-mount sensors designed to utilize Foxboro flanges and hex-head bushings. Used in larger diameter piping and in the sides of tanks.	
-C	Sensors with sanitary fittings mate with 50 mm (2 in) Tri-Clamp™ sanitary fitting. (40 mm (1 1/2 in) Tri-Clamp also available.) (a)	
-D	Insertion sensors are used with gate-valve insertion systems that allow the sensor to be inserted or removed from the system without shutting down the system.	
-E	Twist-Lock sensors are used with mating cell holders. A quarter turn by hand permits cell removal for inspection and cleaning, or for an occasional grab sample.	
-F	Threaded bushings, 3/4 NPT with 1/2 NPT conduit connector.	
-G	Dip sensors are used manually in exposed liquids for occasional checks. Has Noryl™ body.	
-K	High temperature. Bushing is 3/4 NPT with Teflon-S coating. 100 Ω RTD. Cable rated to 150° C (300° F). Same application as for -A above.	
-L	High temperature with sanitary fitting, 100 Ω RTD, and cable rated to 150° C (300° F). Same application as for -C above. (Also available with 40 mm (1 1/2 in) Tri-Clamp.) (a)	
-M	High temperature insertion type with 100 Ω RTD, and cable rated to 150° C (300° F). Same application as for -D above.	

(a) Contact Foxboro.

## STANDARD SPECIFICATIONS

### Wetted Parts Materials

See Table 1 below.

### Temperature and Pressure Limits

See Table 2 on next page.

### Conductivity Ranges

For both 0.1 cm<sup>-1</sup> and 10 cm<sup>-1</sup> cell-factor sensors. See Table 2 on next page.

### Resistivity Ranges

For 0.1 cm<sup>-1</sup> cell factor sensor only. See Table 2 on next page.

### Temperature Compensator (Integral)

See Table 2 on next page.

### Cable

Sensor Models 871CC-A to 871CC-G have integral PVC-insulated cable rated to 105° C (220° F); Sensor Models 871CC-K to 871CC-M have integral Tefzel™ insulated cable rated to 150° C (300° F). Cables are 6 m (20 ft) long, screened (shielded), terminated in numbered spade lugs, or lugless. Type of cable used and method of attaching the cable to the sensor are matched to the application and mounting of sensor.

### Mounting

See “Sensor Application” table for mounting specifications.

Table 1. Process Wetted Parts

Sensors with 3/4 NPT Bushing or Twist-Lock Process Connection						
Cell Factor	Sensor Body Code	Seals/O-Rings	Insulator	Removable Sheath	Bushing	Electrodes
0.1 cm <sup>-1</sup>	-A	EPDM	Ryton (a)	None	Teflon-S Coated 300 Grade ss	Titanium or Monel, as specified by Model Code
	-F	EPDM	Ryton	None		
	-K	EPDM	pctfe (a)	None		
	-E	EPDM	Ryton	None	None (Twist Lock)	
10 cm <sup>-1</sup>	-A	EPDM	Noryl	ptfe (a)	Teflon-S Coated 300 Grade ss	High Density Graphite Encapsulated in Gold-Plated Cups
	-F	EPDM	Noryl	ptfe		
	-K	EPDM	pctfe	ptfe		
	-E	EPDM	Noryl	ptfe	None (Twist Lock)	
Universal-Mount, Insertion, and Dip Sensors						
Cell Factor	Sensor Body Code	Seals/O-Rings	Insulator	Removable Sheath	Upper Housing	Electrodes
0.1 cm <sup>-1</sup>	-B	EPDM	Ryton	None	316 ss	Titanium or Monel, as specified by Model Code
	-G	EPDM	Ryton	None	Noryl	
	-D	EPDM	Ryton	None	316 ss (Includes Insertion Shaft)	
	-M	EPDM	pctfe	None		
10 cm <sup>-1</sup>	-B	EPDM	Noryl	ptfe	316 ss	High Density Graphite Encapsulated in Gold-Plated Cups
	-G	EPDM	Noryl	ptfe	Noryl	
	-D	EPDM	Noryl	ptfe	316 ss (Includes Insertion Shaft)	
	-M	EPDM	pctfe	ptfe		
Sensors with Sanitary Fittings						
Cell Factor	Sensor Body Code	Seals/O-Rings	Insulator	Removable Sheath	Tri-Clamp	Electrodes
0.1 cm <sup>-1</sup>	-C	EPDM	Ryton	None	316 ss	Titanium or Monel, as specified by Model Code
	-L	EPDM	pctfe	None	316 ss	
10 cm <sup>-1</sup>	-C	EPDM	Noryl	ptfe	316 ss	High Density Graphite Encapsulated in Gold-Plated Cups
	-L	EPDM	pctfe	ptfe	316 ss	

(a) Ryton is polyphenylene sulfide; ptfe is polytetrafluoroethylene; pctfe is polychlorotrifluoroethylene.

Table 2. Pressure & Temperature Limits, Conductivity & Resistivity Ranges, Temperature Compensator

Sensor Body Code	Temperature Limits (e)(f)	Pressure Limits	Applicable Conductivity and Resistivity Ranges		Temperature Compensator (Integral)
			Cell Factor 0.1 cm <sup>-1</sup> (a)	Cell Factor 10 cm <sup>-1</sup>	
-A to -G	0 and 120° C (32 and 250° F)	-0.1 and +1.4 MPa (-15 and +200 psi)	From 0 to 1 through 0 to 200 μS/cm Conductivity Range	Beyond 0 to 200 through 200 to 20,000 μS/cm Conductivity Range	100 kΩ Thermistor for use with: 873RS, 873ARS, 873CC, 873ACC, and 875CR Series Analyzers; 870CC Series Transmitters; 870ITCR Series Transmitters
-K to -M	120° C at 3.4 MPa (250° F at 500 psi); 150° C at 2.5 MPa (300° F at 375 psi); 175° C at 1.7 MPa (350° F at 250 psi) (b)		From 0 to 2 through 0 to 20 MΩ•cm Resistivity Range(d)		100 Ω Platinum RTD for use with: 873RS, 873ARS, 873CC, 873ACC and 875CR Series Analyzers; 870ITCR Series Transmitters

- (a) All 0.1 cm<sup>-1</sup> cell-factor sensors with Body Codes A through M are labeled with the exact cell factor and temperature cell factor. All 0.1 cm<sup>-1</sup> cell-factor sensors are constructed and tested for an accuracy of better than ±2%.
- (b) Specifications are for 0.1 cm<sup>-1</sup> cell-factor sensors only. Maximum temperature for 10 cm<sup>-1</sup> cell-factor sensor is 150° C at 2.5 MPa (300° F at 375 psi).
- (c) If -K, -L, or -M sensor is to be used with 870CC Series Transmitters, no automatic temperature compensation can be applied. RTD's are not supported in these instruments.
- (d) Specify Option Code -9.
- (e) Temperature limits for optimum performance and compensation: 871CC-A through 871CC-G = 15 and 40° C (60 and 105° F); 871CC-K through 871CC-M = 15 and 80° C (60 and 175° F).
- (f) Recalibration is recommended for 10 cm<sup>-1</sup> cell-factor sensors after exposure to elevated temperatures.

**PRODUCT SAFETY SPECIFICATIONS**

Testing Laboratory, Types of Protection, and Area Classification	Application Conditions	Electrical Safety Design Code
<b>ATEX</b> Type n energy limited for II 3 GD, EEx nL IIC, Zone 2.	Temperature Class T3-T6. T110°C-T260°C. Connect to instrument per MI 611-208.	CS-E/ANN
<b>ATEX</b> Intrinsically Safe for II 1 GD, EEx ia IIC, Zone 0.	Temperature Class T3-T6. T110°C-T260°C. Connect to instrument per MI 611-208.	CS-E/AAA
<b>CSA</b> intrinsically safe Class I, Division 1, Groups A, B, C, and D; Class II, Division 1, Groups E, F, and G hazardous locations.	Connect to 870CC Transmitter per MI 611-206.	CS-E/CB-A
<b>CSA</b> ordinary locations.	Connect to 873CC or 873ACC Analyzer with Supply Voltage Code -A, -E, or -J, and Enclosure Code P, W, X, Y, or Z.	CS-E/CG-A
<b>CSA</b> Class I, Division 2, Groups A, B, C, and D hazardous locations.	Connect to 873CC or 873ACC Analyzer with Supply Voltage Code -A, -E, or -J, and Enclosure Code W, X, Y, or Z. Connect per MI 611-206.	CS-E/CN-A
<b>CSA</b> suitable for Class I, Division 2, Groups A, B, C, and D; Class II, Division 2, Groups E, F, and G; Class III Division 2.	Connect to 875CR Transmitter. Supply Voltage -A, -B, -C, -E, and -J. Temperature Class T4 at 85°C max ambient.	875CR-..C
<b>CSA</b> ordinary location.	Connect to 875CR Transmitter. Supply Voltage -A, -B, -C, -E, and -J. Temperature Class T4, Ta = 85°C maximum ambient.	875CR-..C
<b>CSA</b> certified for Class I, II, and III, Division 2, Groups A, B, C, D, F, and G hazardous locations.	Temperature Class T4. Connect to 870ITCR Transmitter per MI 611-206.	870ITCR-..CNZ

Testing Laboratory, Types of Protection, and Area Classification	Application Conditions	Electrical Safety Design Code
<b>CSA</b> certified intrinsically safe for Class I, II, and III, Division 1, Groups A, B, C, D, F; and G Division 2 hazardous locations.	Temperature Class T4. Connect to 870ITCR Transmitter per MI 611-206.	870ITCR-..CAA
European nonincendive, Zone 2.	Connect to any nonincendive circuit. Use on non-hazardous pipeline only.	CS-E/XN-F
<b>FM</b> intrinsically safe Class I, II, and III, Division 1, Groups A, B, C, D, E, F, and G hazardous locations.	871CC-...-6 Sensors are excluded. Connect to 870 Series Transmitter per MI 611-206.	CS-E/FB-A
<b>FM</b> ordinary locations.	Connect to 873CC or 873ACC Analyzer with Enclosure Code P, W, X, Y, or Z.	CS-E/FG-A
<b>FM</b> nonincendive Class I, Division 2, Groups A, B, C, and D; Class II, Division 2, Groups F and G; Class III, Division 2.	Connect to 875CR Transmitter. Supply Voltage -A, -B, -C, and -J. Temperature Class T4A, Ta = 75°C.	875CR-..F
<b>FM</b> ordinary location.	Connect to 875CR Transmitter. Supply Voltage -A, -B, -C, and -J. Temperature Class T4A Ta = 75°C.	875CR-..F
<b>FM</b> approved nonincendive for Class I, II, and III, Division 1, Groups A, B, C, D, F, and G; and Division 2 hazardous locations.	Temperature Class T4. Connect to 870ITCR Transmitter per MI 611-206.	870ITCR-..FNZ
<b>FM</b> approved intrinsically safe for Class I, II, and III, Division 1, Groups A, B, C, D, E, F, and G hazardous locations.	Temperature Class T4. Connect to 870ITCR Transmitter per MI 611-206.	870ITCR-..FAA

---

**ACCESSORIES**
**Accessory Selection Table** (For additional accessory specifications, see sections that follow.)

Accessory	Description	Select Foxboro Part
Gate Valve Assembly (Used with Sensor Body Code -D or -M)	Standard Pressure-Temperature Rating	0051351
	High Pressure-Temperature Rating	0051356
Flange, AISI Type 316 stainless steel (316 ss)	2 in	0051199
	DN 50 (50 mm)	BS805JL
	2 1/2 in	0051196
	3 in	0051197
	4 in	0051198
	DN 100 (100 mm)	BS805JM
Bushing, 316 ss (a)	1 1/4 NPT	0051174
	1 1/4 NPT	0051191
	1 1/2 NPT	0051175
	1 1/2 NPT	0051192
	R 1 1/2 Metric	BS805JJ
	2 NPT	0051193
	R 2 Metric	BS805JC
Bushing, Carpenter™ 20 Cb	1 1/4 NPT	0051176
	1 1/2 NPT	0051177
	R 1 1/2 Metric	BS805JK
	2 NPT	0051178
	R 2 Metric	BS805JD
Bushing, Kynar™	1 1/2 NPT	BS805JF
	R 1 1/2 Metric	BS805JH
	2 NPT	BS805HZ
	R 2 Metric	BS805JB
Bushing, Noryl	1 1/2 NPT	BS805JE
	R 1 1/2 Metric	BS805JG
	2 NPT	BS805HY
	R 2 Metric	BS805JA
Bushing, PVC (a)	1 1/4 NPT	0051183
Flow Chamber (b)	Twist-Lock (PVC)	0051181
	Twist-Lock (316 ss)	0051179
	3/4 NPT Threaded (PVC)	0051182
	3/4 NPT Threaded (316 ss)	0051180
	3/4 NPT Threaded (Sygef™)	BS805GR
Junction Box	Meets IEC IP65 and NEMA 4 specifications, watertight fittings	0051052
Extension Cable Assembly	<u>With</u> spade terminals. Specify length up to 150 m (500 ft) (c)	0061101
Extension Cable	<u>Without</u> spade terminals. Specify length up to 150 m (500 ft) (c)	6000-062
Patch Cord	<u>Standard Length</u> : 3 m (10 ft)	BS805UA
	<u>Nonstandard Length</u> : Specify Length up to 30 m (100 ft) (c)	BS805UB

(a) See Table 7 for rated pressure at rated temperature selections.

(b) See Table 5 for rated pressure at rated temperature selections.

(c) See Table 8 for maximum allowable total cable/patch-cord length between sensor and measuring instrument.



**ACCESSORIES (Cont.)**

**Gate Valve Assembly**

A gate valve assembly enables the user to easily install and withdraw the insertion sensor (Sensor Body Code -D or -M) while the process is pressurized. The small diameter insertion shaft gives a 1:10 ratio of insertion force to process pressure {e.g., at a process pressure of 1.4 MPa (200 psi), only 89 N (20 lbf) is required to insert the sensor}. The damping effect of process liquid, trapped behind sensor, adds a safety factor by slowing the passage of the sensor into the isolation chamber. See Tables 3 and 4 for additional specifications and Part Numbers.

Table 3. Gate Valve Assemblies (a)

Process Line Connection (in)	Pressure Rating	0051351 Illustrated 
1 NPT	Standard Rating (0051351) High-Pressure Rating (0051356)	

(a) For use with 871CC-D or 871CC-M Sensor. Sensor is not included with the Valve Assembly.

Table 4. Gate Valve Assembly Specifications

Process Line Connection (in)	Rated Pressure at Rated Temperature				Material of Process Wetted Parts			Used with Sensor Mounting Design	Gate Valve Insertion (Foxboro Part Number)
	MPa	psi	°C	°F	Gate Valve	Shock Absorber	O-Ring (a)		
1 NPT	1.4	200	120	250	316 ss	ptfe	EPDM	-D, -M	0051351
	3.4	500	175	350	316 ss	ptfe	EPDM	-M	0051356

(a) The o-ring is located on the Sensor Assembly and is not part of the Gate Valve Assembly.

**Flow Chambers**

Flow chambers offer a convenient way of mounting sensors in a system where the sample is provided by a small diameter sample line. The flow chamber connects to the system via user supplied 1/4 NPT

fittings and provides a chamber for the sample. A flow chamber with a sensor in place will pass up to 125 mL/s (2 gpm) of sample. See Table 5 for additional specifications and Part Numbers.

Table 5. Flow Chamber Specifications

Sensor Connector	Material	Rated Pressure at Rated Temperature				Foxboro Part	Used with Sensor Mounting Design	 0051179 Illustrated
		MPa	psi	°C	°F			
Twist-Lock	PVC	0.4	60	50	120	0051181	-E	
		0.2	30	80	175			
Twist-Lock	316 ss	1.4	200	125	260	0051179	-E	
3/4 NPT Threaded	PVC	0.4	60	50	120	0051182	-A	
		0.2	30	80	175			
3/4 NPT Threaded	316 ss	14	2000	175	350	0051180	-A -K	
3/4 NPT Threaded	Sygef	0.4	60	50	120	BS805GR	-A	
		0.2	30	80	175			

**ACCESSORIES (Cont.)**

**Flanges and Bushings**

Foxboro raised-face flanges and hex-head bushings are used for permanent installations in pipelines and tanks. Flanges are used with universal mount sensors (Sensor Body Code -B) in systems using process piping larger than 3/4 in, while hex-head bushings can

be used with either universal or Twist-Lock mounting design. Flanges come complete with spacers and locknut, while the bushings come complete with locknut. See Tables 6 (flanges) and 7 (bushings) for additional specifications and Part Numbers.

Table 6. Flange Specifications – Flat Faced (FF) or Raised Face (RF), as Indicated

Size (a)	Material	Foxboro Part
2 in, FF	316 ss	0051199
DN 50, RF	316 ss	BS805JL
2 1/2 in, FF	316 ss	0051196
3 in, FF	316 ss	0051197
4 in, FF	316 ss	0051198
DN 100, RF	316 ss	BS805JM



0051198 Illustrated

(a) Pressure and temperature rating: DIN 2501, 10 bar, for DN 50 and DN 100 sizes. MS Class 150LW for 2, 2 1/2, 3, and 4 in sizes. Used with sensor having Universal Mounting Design (Code -B).

Table 7. Hex-Head Bushing Specifications

Thread Size (in)	Material	Rated Pressure at Rated Temperature				Foxboro Part	Used with Sensor Mounting Design
		MPa	psi	°C	°F		
1 1/4 NPT	PVC	0.4	60	50	120	0051183	Twist-Lock (-E)
		0.2	30	80	175		
1 1/4 NPT	316 ss	1.4	200	125	260	0051174	Twist-Lock (-E)
1 1/2 NPT	316 ss	1.4	200	125	260	0051175	
1 1/4 NPT	316 ss	1.4	200	125	260	0051191	Universal (-B)
1 1/2 NPT	316 ss	1.4	200	125	260	0051192	
R 1 1/2	316 ss	1.4	200	125	260	BS805JJ	
2 NPT	316 ss	1.4	200	125	260	0051193	
R 2	316 ss	1.4	200	125	260	BS805JC	
1 1/4 NPT	Carpenter 20 Cb	1.4	200	125	260	0051176	Universal (-B)
1 1/2 NPT	Carpenter 20 Cb	1.4	200	125	260	0051177	
R 1 1/2	Carpenter 20 Cb	1.4	200	125	260	BS805JK	
2 NPT	Carpenter 20 Cb	1.4	200	125	260	0051178	
R 2	Carpenter 20 Cb	1.4	200	125	260	BS805JD	
1 1/2 NPT	Kynar	1.0	150	25	75	BS805JF	Universal (-B)
R 1 1/2	Kynar	0.4	60	80	175	BS805JH	
2 NPT	Kynar	0.2	30	120	250	BS805HZ	
R 2	Kynar	0.2	30	120	250	BS805JB	
1 1/2 NPT	Noryl	1.4	200	75	75	BS805JE	Universal (-B)
R 1 1/2	Noryl	0.7	100	80	175	BS805JG	
2 NPT	Noryl	0.3	50	95	200	BS805HY	
R 2	Noryl	0.3	50	95	200	BS805JA	

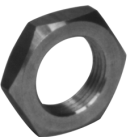
0051191 Illustrated

**Junction Box (Not recommended for resistivity measurement)**

The junction box (Figure 1) mounts to a surface and provides a convenient means of connecting the sensor cable to the extension cable (see Extension Cable Assembly section). The junction box is weatherproof and dusttight as defined by IEC IP65 and provides the watertight protection of NEMA Type 4. Specify Part Number 0051052.

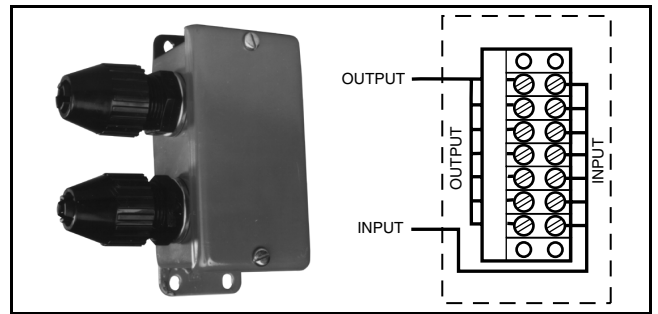

Figure 1. Junction Box and Terminal Connectors (Foxboro Part 0051052)

**Extension Cable Assembly (Not recommended for resistivity measurement)**

The extension cable assembly (Figure 2) is a PVC-jacketed multi-conductor cable with numbered leads, and is terminated with spade lugs on both ends allowing it to be connected to the terminals in a junction box (Figure 1) and in the measuring instrument. See Table 8 below for cable application, Part Number, and maximum allowable total cable/patch-cord length between the sensor and the instrument.

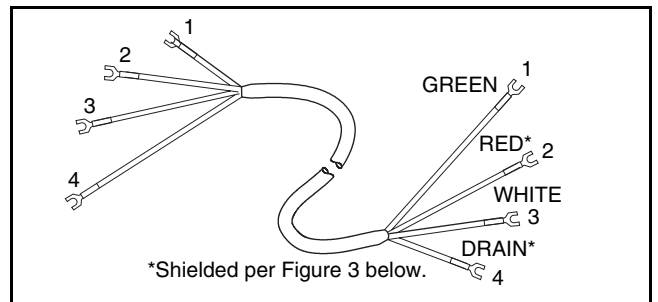

Figure 2. Extension Cable Assembly (Foxboro Part 0061101)

**Extension Cable (Not recommended for resistivity measurement)**

The extension cable (Figure 3) is a PVC-jacketed multi-conductor cable. The cable is not dressed and has no terminations. See Table 8 below for cable application, Part Number, and maximum allowable total cable/patch-cord length between the sensor and the measuring instrument.

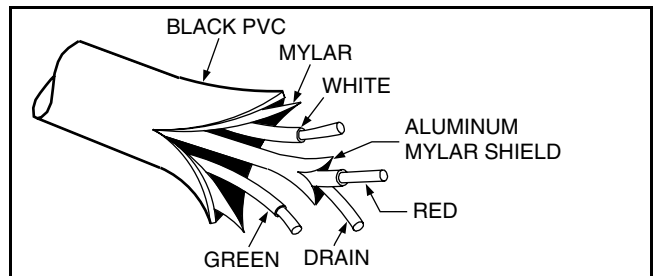

Figure 3. Extension Cable (Foxboro Part 6000-062)

**Patch Cord (Not recommended for resistivity measurement)**

Patch cords (not shown) provide connections between sensors with optional suffixes -5, -6, -7, and a transmitter, analyzer, switch, or junction box. One end of the patch cord has a socket for connection to the sensor; the other end has numbered leads. See Table 8 below for patch cord application, Part Number, and maximum allowable total cable/ patch-cord length between the sensor and the measuring instrument.

Table 8. Extension Cable and Patch Cord Usage

Measuring Instrument Model	Accepts Spade Lugs	Max. Cable/Patch-Cord Length (a)		Part Number (Specify)	
		meters	feet	Recommended Extension Cable	Patch Cord
870ITCR	YES	30	100	0061101	3 m (10 ft) Length: BS805UA Lengths to 30 m (100 ft): BS805UB (Specify Length)
875CR	YES	30	100		
873CC	NO	150	500	6000-062	
873ACC	NO	150	500		

(a) Maximum allowable total cable/patch-cord length between the sensor and the measuring instrument.

**DIMENSIONS—NOMINAL**

**mm**  
**in**

**SENSOR MOUNTING**

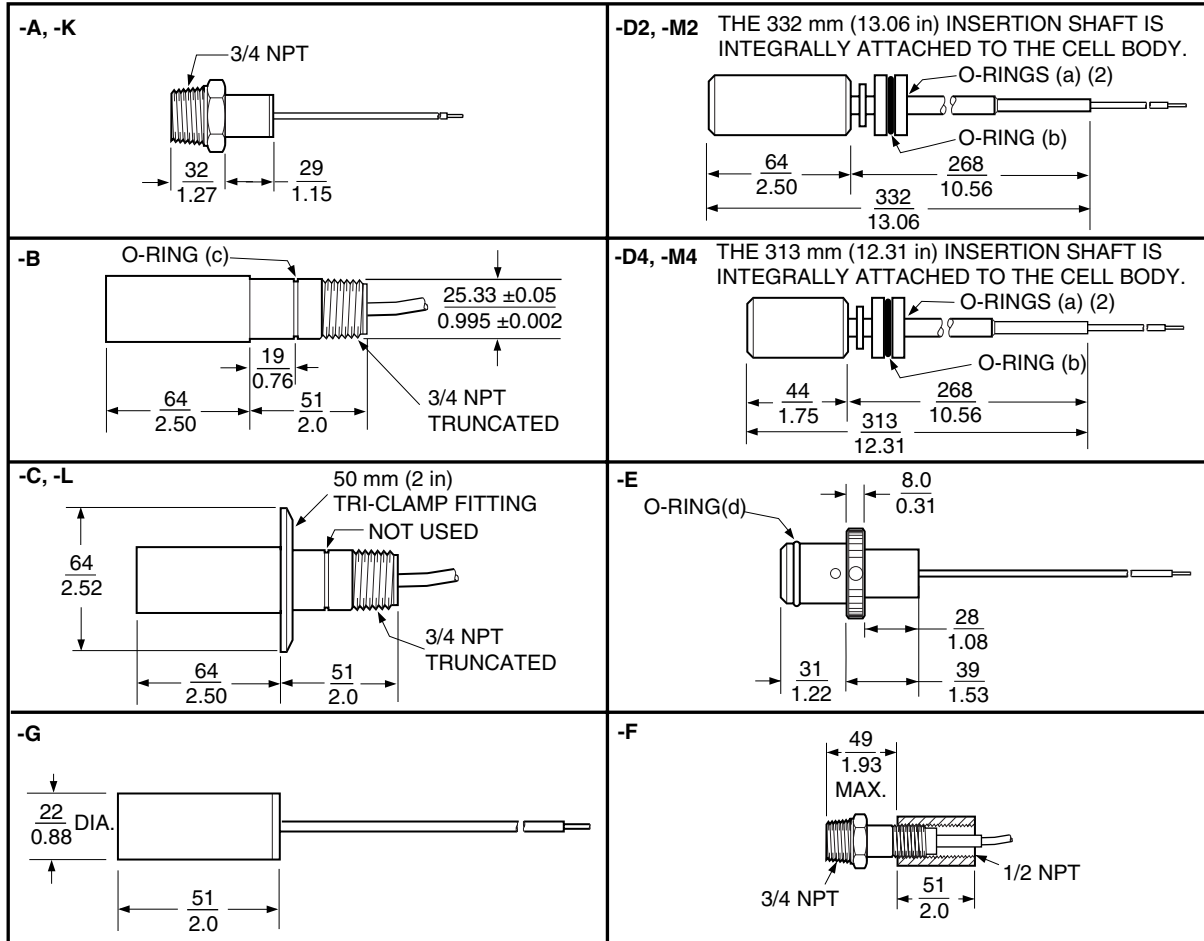

NOTE: O-RINGS PER AEROSPACE STANDARD AS-568A AS FOLLOWS:

- (a) No. 2-012
- (b) No. 2-117
- (c) No. 2-020
- (d) No. 2-116

**CELL MOUNTING**

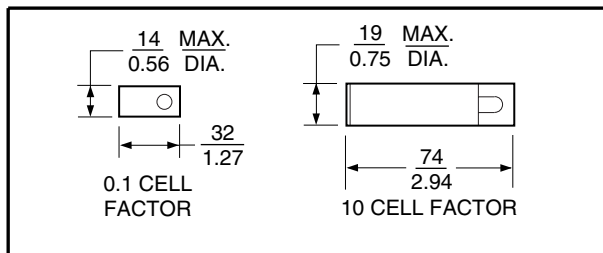

NOTE:

For total sensor length, add cell factor length (shown at left) to the left of the sensor mounting length (above).

For available cable lengths, refer to the Model Code and Accessories sections.







**ORDERING INSTRUCTIONS**

1. Model Number
2. Cable length, if nonstandard
3. Accessories, as required. Specify Foxboro Part Number and cable length.
4. Customer tag data
5. Contact Name (for order inquiries)

**OTHER M&I PRODUCTS**

Invensys Foxboro provides a broad range of measurement and instrument products, including solutions for pressure, flow, analytical, positioners, temperature, controlling and recording. For a listing of these offerings, visit the Invensys Foxboro web site at:

[www.foxboro.com/instrumentation](http://www.foxboro.com/instrumentation)